

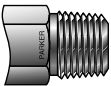













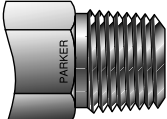

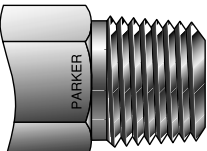
螺纹	直螺纹	Tubing O.D. Size
 1/16"	 5/16-24	 1/16"
 1/8" (1/8-27)	 7/16-20	 1/8"
 1/4" (1/4-18)	 1/2-20	 3/16"
 3/8" (3/8-18)	 9/16-18	 1/4"
 1/2" (1/2-14)	 3/4-16	 5/16"
 3/4" (3/4-14)	 7/8-14	 3/8"
 1" (1"-11 1/2)	 1-1/16-12	 1/2"
American Standard Pipe Thread (NPT)	American Standard Unified Thread (Straight)	 5/8"
		 3/4"
60° thread angle • Pitch measured in inches • Truncation of root and crest are flat • Taper angle 1°47'	60° thread angle • Pitch measured in inches • Truncation of root and crest are flat • Diameter measured in inches	 7/8"
		 1"

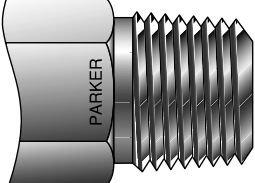

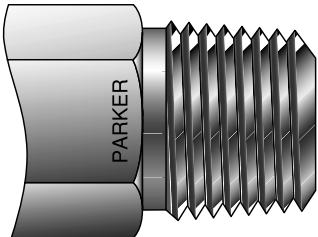
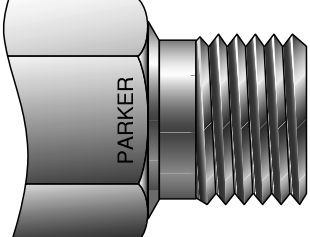
螺纹

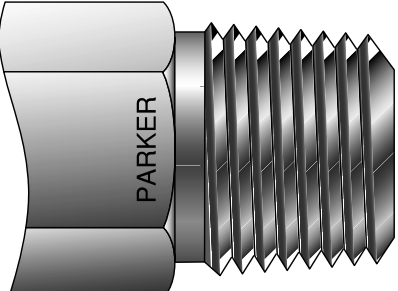
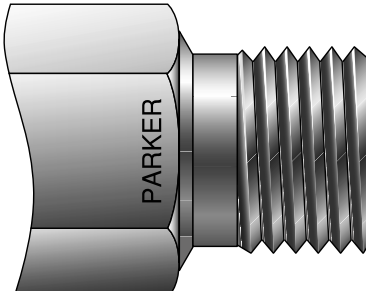
Tubing O.D. Size

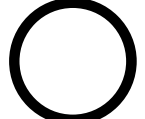
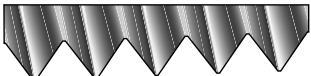
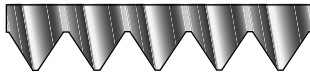
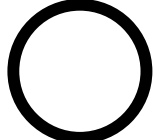
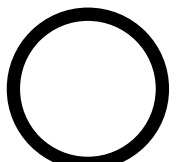
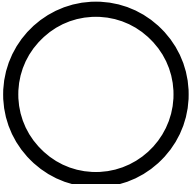
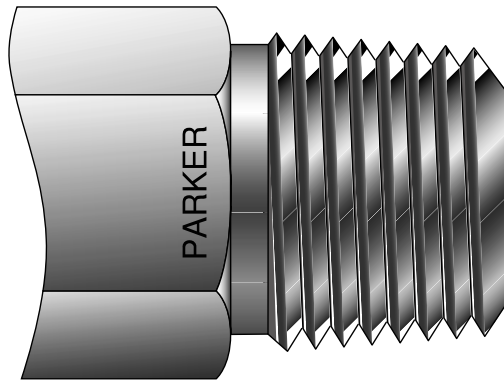

1-1/4"
(1-1/4" - 11-1/2")

Tubing O.D. Size

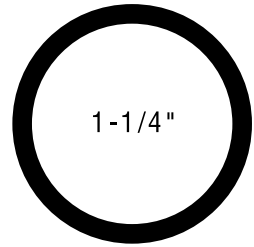

1-1/4"

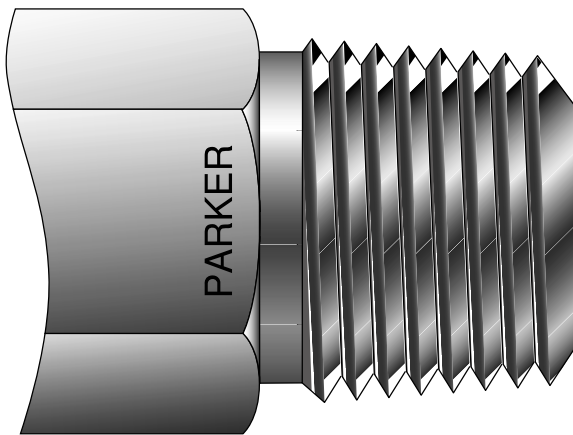

1-1/2"
(1-1/2" - 11-1/2")

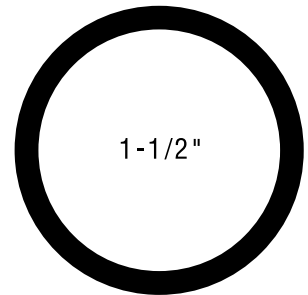

1-1/2"

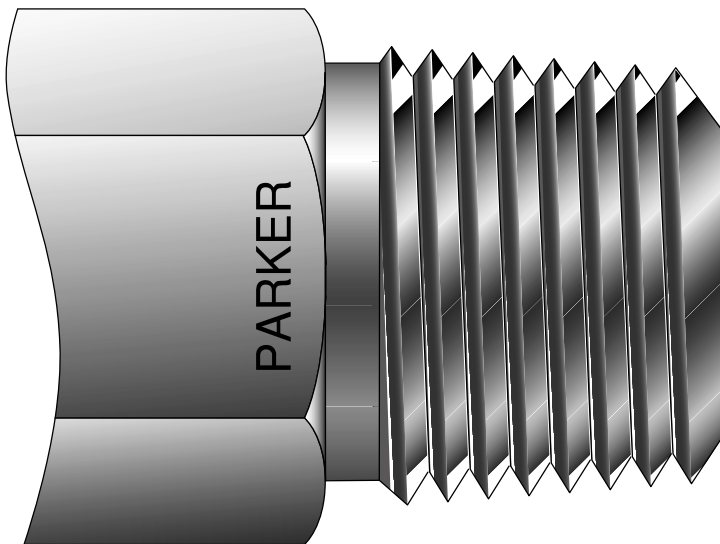

2"
(2" - 11-1/2")

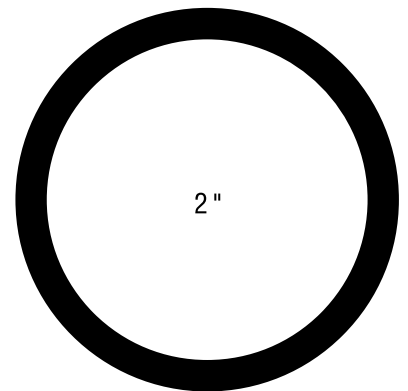

2"

BSPT Tapered Thread

BSPP Parallel Thread

Tubing O.D. Size

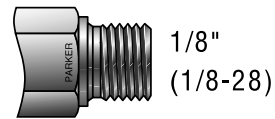
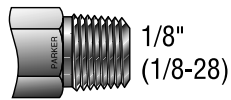

○ 2 m m

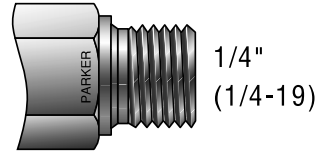
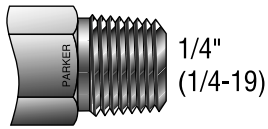

○ 3 m m

○ 4 m m

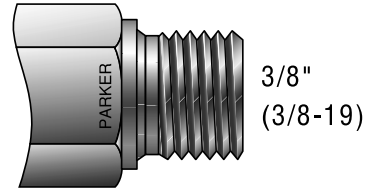
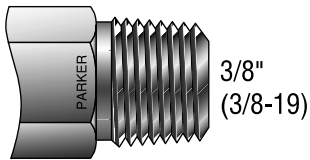

○ 6 m m

○ 8 m m

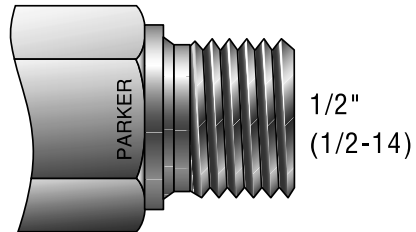
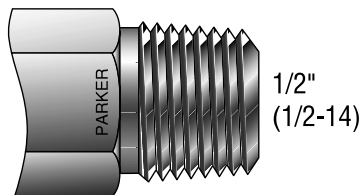

○ 10 m m

○ 12 m m

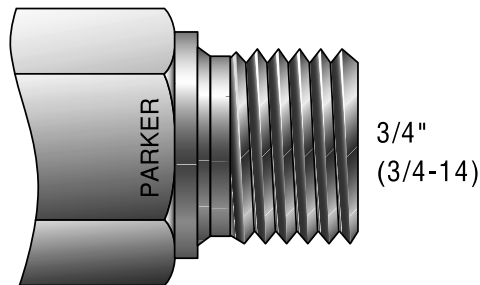
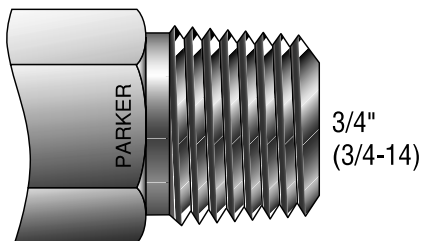

○ 14 m m

○ 15 m m

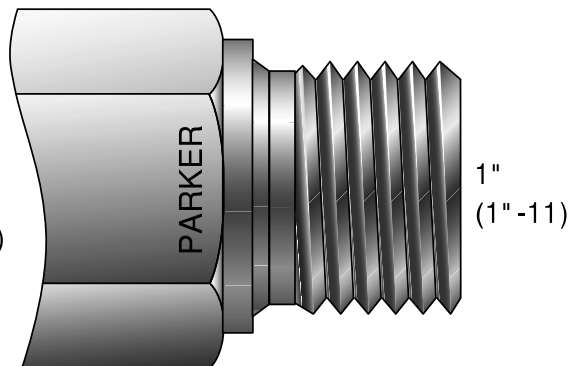
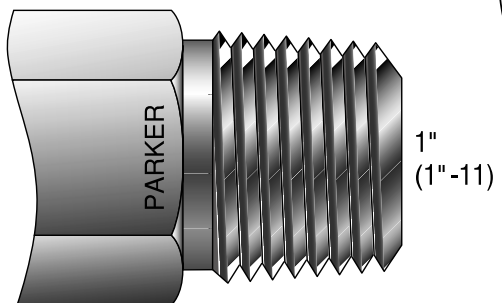

○ 16 m m

○ 18 m m

○ 20 m m

○ 22 m m

International Organization for Standards (ISO 7/1)

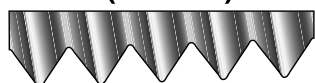

- 55° thread angle • Pitch measured in inches
- Truncation of root and crest are round
- Taper angle 1°47'

(ISO 228/1)

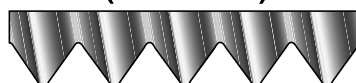

- 55° thread angle • Pitch measured in inches
- Truncation of root and crest are round
- Diameter measured in inches

○ 25 m m